

# VMH 35-D

## MARINE DISPLAY

USER MANUAL  
rev. AA



EN

DE

IT

FR

ES

PT

# TABLE OF CONTENTS

<b>INTRODUCTION</b> .....	<b>3</b>	Units.....	17
Architecture.....	3	Clock.....	17
<b>SAFETY INFORMATION</b> .....	<b>4</b>	Select the Pages to Display.....	17
Safety during Installation.....	4	Setup Menu.....	18
Safety after Installation.....	5	Engine Identification.....	18
Electrical Connection.....	5	Select a J1939 Source.....	18
<b>INSTALLATION</b> .....	<b>6</b>	Adjust the RPM Scale.....	19
Before the Assembly.....	6	Reset a Trip Value.....	19
Spinlock Mounting.....	7	Upload a Custom Splash Logo.....	19
<b>ELECTRICAL CONNECTIONS</b> .....	<b>8</b>	<b>SENSOR CONFIGURATION</b> .....	<b>20</b>
Pinout.....	8	Types of Calibration.....	20
NMEA 2000® Connector Pinout.....	8	Sensors Menu Structure.....	20
Electrical Schematic.....	9	Calibrate the Sensors.....	21
Analog Sensors.....	9	Selecting a Source for Voltage Data.....	22
External Buzzer (B1).....	9	<b>SENSOR CURVES</b> .....	<b>23</b>
Day / Night Mode Switch (S1).....	10	<b>ALARMS</b> .....	<b>25</b>
Connection to the NMEA 2000® Network.....	10	Alarms Notification.....	25
<b>DESCRIPTION</b> .....	<b>11</b>	Alarms Menu Structure.....	25
Display Segments.....	11	Set an Alarm.....	25
Data Pages.....	11	List of Managed Alarms.....	26
Basic Actions.....	12	Alarm Telltales.....	26
Managed Data.....	12	<b>TROUBLESHOOTING</b> .....	<b>27</b>
Distance Traveled.....	13	<b>TECHNICAL DATA</b> .....	<b>28</b>
Engine Hours.....	14	General Features.....	28
Priority of Data Sources.....	14	Environmental Features.....	28
<b>GENERAL SETTINGS</b> .....	<b>15</b>	Electrical Features.....	28
Settings Menu Structure.....	15	Compliance.....	29
Operate the Settings Menu.....	15	Supported NMEA 2000 Messages.....	29
Display Menu Structure.....	16	Disposal Responsibility.....	29
Change the Brightness of the Display.....	16	<b>SPARE PARTS AND ACCESSORIES</b> .....	<b>30</b>
Set the Day/Night Mode.....	16		

# INTRODUCTION

The VMH 35-D is the perfect standalone solution for monitoring your diesel engine. With a configurable dial scale of 3000 or 4000 RPM, the VMH 35-D is a compact display capable of showing a wide amount of data from your engine, battery, tank, and GPS.

Specific information about your diesel engine is provided together with alarms, either received from the SAE J1939 bus or locally set through the embedded menu. Both 12V and 24V systems are supported, as well as EasyLink connectivity which allows your dashboard to be expanded with additional VMH 14 satellite displays to always keep your sensitive data under control.

The Veratron VMH 35 is designed with a mineral glass front that's optically bonded to the sun-readable hybrid display.

A sleek, brushed stainless steel bezel surrounds the device and fits into classic and modern marine décors.

The embedded NMEA 2000 gateway distributes sensor data inputs such as fuel, trim and tachometer to other devices like chartplotters, saving the need for an additional external converter.

Powered by the latest microprocessor, the Veratron VMH 35 is blazingly fast. Yet even when set at full brightness, it draws a mere 170mA of power—a fraction of what comparably-sized TFT screens use.

The GPS-Version (B001711) comes with an embedded high-performance GNSS receiver which further enhances the display capabilities by adding speed, position and heading data.

## ARCHITECTURE

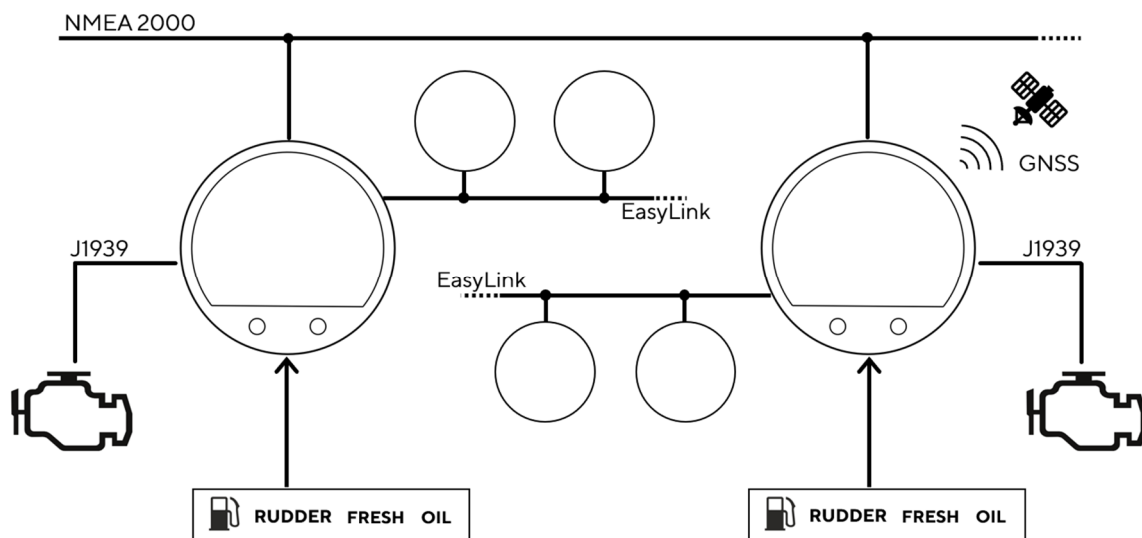

# SAFETY INFORMATION

## WARNING

- No smoking! No open fire or heat sources!
- The product was developed, manufactured and inspected according to the basic safety requirements of EC Guidelines and state-of-the-art technology.
- The instrument is designed for use in grounded vehicles and machines as well as in pleasure boats, including non-classified commercial shipping.
- Use our product only as intended. Use of the product for reasons other than its intended use may lead to personal injury, property damage or environmental damage. Before installation, check the vehicle documentation for vehicle type and any possible special features!
- Use the assembly plan to learn the location of the fuel/hydraulic/compressed air and electrical lines!
- Note possible modifications to the vehicle, which must be considered during installation!
- To prevent personal injury, property damage or environmental damage, basic knowledge of motor vehicle/shipbuilding electronics and mechanics is required.
- Make sure that the engine cannot start unintentionally during installation!
- Modifications or manipulations to Veratron products can affect safety. Consequently, you may not modify or manipulate the product!
- When removing/installing seats, covers, etc., ensure that lines are not damaged, and plug-in connections are not loosened!
- Note all data from other installed instruments with volatile electronic memories.

## SAFETY DURING INSTALLATION

- During installation, ensure that the product's components do not affect or limit vehicle functions. Avoid damaging these components!
- Only install undamaged parts in a vehicle!
- During installation, ensure that the product does not impair the field of vision and that it cannot impact the driver's or passenger's head!
- A specialized technician should install the product. If you install the product yourself, wear appropriate work clothing. Do not wear loose clothing, as it may get caught in moving parts. Protect long hair with a hair net.
- When working on the on-board electronics, do not wear metallic or conductive jewelry such as necklaces, bracelets, rings, etc.
- If work on a running engine is required, exercise extreme caution. Wear only appropriate work clothing as you are at risk of personal injury, resulting from being crushed or burned.
- Before beginning, disconnect the negative terminal on the battery, otherwise you risk a short circuit. If the vehicle is supplied by auxiliary batteries, you must also disconnect the negative terminals on these batteries! Short circuits can cause fires, battery explosions and damages to other electronic systems. Please note that when you disconnect the battery, all volatile electronic memories lose their input values and must be reprogrammed.
- If working on gasoline boat motors, let the motor compartment fan run before beginning work.
- Pay attention to how lines and cable harnesses are laid so that you do not drill or saw through them!
- Do not install the product in the mechanical and electrical airbag area!

## SAFETY INFORMATION

- Do not drill holes or ports in load-bearing or stabilizing stays or tie bars!
- When working underneath the vehicle, secure it according to the specifications from the vehicle manufacturer.
- Note the necessary clearance behind the drill hole or port at the installation location. Required mounting depth: 65 mm.
- Drill small ports; enlarge and complete them, if necessary, using taper milling tools, saber saws, keyhole saws or files. Deburr edges. Follow the safety instructions of the tool manufacturer.
- Use only insulated tools, if work is necessary on live parts.
- Use only the multimeter or diode test lamps provided, to measure voltages and currents in the vehicle/machine or boat. Use of conventional test lamps can cause damage to control units or other electronic systems.
- The electrical indicator outputs and cables connected to them must be protected from direct contact and damage. The cables in use must have enough insulation and electric strength and the contact points must be safe from touch.
- Use appropriate measures to also protect the electrically conductive parts on the connected consumer from direct contact. Laying metallic, uninsulated cables and contacts is prohibited.

## SAFETY AFTER INSTALLATION

- Connect the ground cable tightly to the negative terminal of the battery.
- Reenter/reprogram the volatile electronic memory values.
- Check all functions.
- Use only clean water to clean the components. Note the Ingress Protection (IP) ratings (IEC 60529).

## ELECTRICAL CONNECTION

- Note cable cross-sectional area!
- Reducing the cable cross-sectional area leads to higher current density, which can cause the cable cross-sectional area in question to heat up!
- When installing electrical cables, use the provided cable ducts and harnesses; however, do not run cables parallel to ignition cables or to cables that lead to large electricity consumers.
- Fasten cables with cable ties or adhesive tape. Do not run cables over moving parts. Do not attach cables to the steering column!
- Ensure that cables are not subject to tensile, compressive or shearing forces.
- If cables are run through drill holes, protect them using rubber sleeves or the like.
- Use only one cable stripper to strip the cable. Adjust the stripper so that stranded wires are not damaged or separated.
- Use only a soft soldering process or commercially available crimp connector to solder new cable connections!
- Make crimp connections with cable crimping pliers only. Follow the safety instructions of the tool manufacturer.
- Insulate exposed stranded wires to prevent short circuits.
- Caution: Risk of short circuit if junctions are faulty or cables are damaged.
- Short circuits in the vehicle network can cause fires, battery explosions and damages to other electronic systems. Consequently, all power supply cable connections must be provided with weldable connectors and be sufficiently insulated.
- Ensure ground connections are sound.
- Faulty connections can cause short circuits. Only connect cables according to the electrical wiring diagram.
- If operating the instrument on power supply units, note that the power supply unit must be stabilized and it must comply with the following standard: DIN EN 61000, Parts 6-1 to 6-4.

# INSTALLATION

## ⚠ WARNING

Before starting work, disconnect the ground terminal of the battery to avoid the risk of a short circuit. If the vehicle is equipped with additional batteries, the negative terminal of all batteries must also be disconnected if necessary. Short circuits can burn cables, explode batteries and cause damage to other electronic systems. Remember that by disconnecting the battery, all data entered in the temporary electronic memory will be lost and will have to be reprogrammed.

## BEFORE THE ASSEMBLY

1. Before starting work, switch off the ignition and remove the ignition key.

If necessary, remove the main power switch.

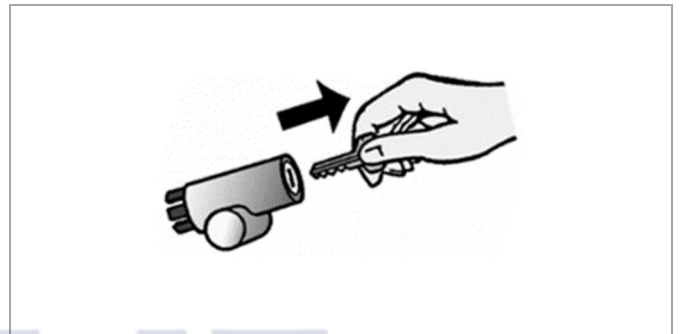

2. Disconnect the negative terminal of the battery. Do not allow the battery to be reconnected by mistake.

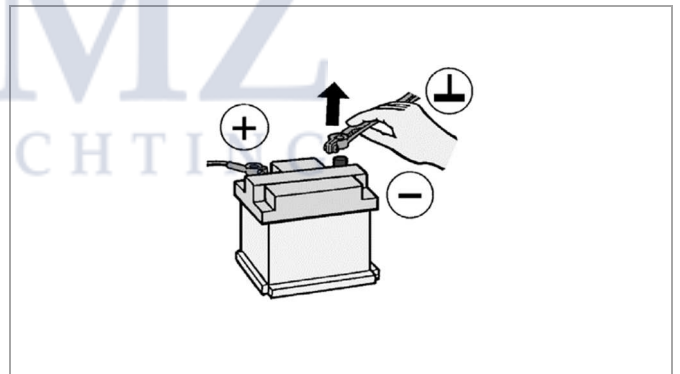

3. When mounting the device in the vicinity of a magnetic compass, maintain a protective distance from the compass.

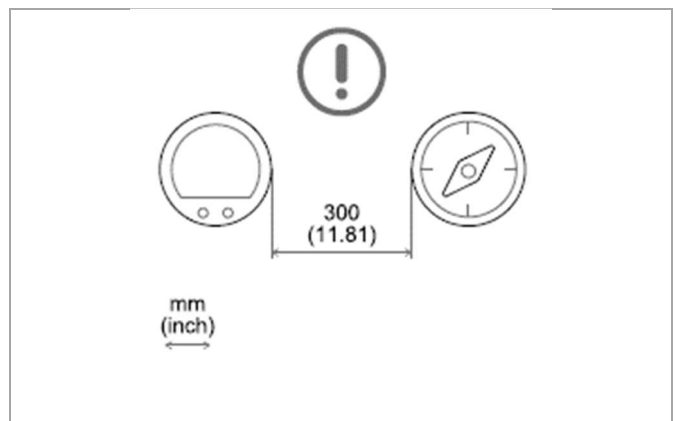

## SPINLOCK MOUNTING

The panel thickness may be within a range of 2 to 15 mm.

The drill hole must have a diameter of 86 mm.

### WARNING

- Do not drill holes or installation openings in supporting or stabilizing beams!
- The mounting location must have sufficient clearance behind the mounting holes or openings. The required mounting depth is 65 mm.
- Drill small holes with the drill, if necessary, enlarge them using a conical cutter, scroll saw, tail saw or file and finish them. Deburr the edges. It is essential to observe the safety instructions of the tool manufacturer.

1. Create a circular hole in the panel considering the footprint of the device.

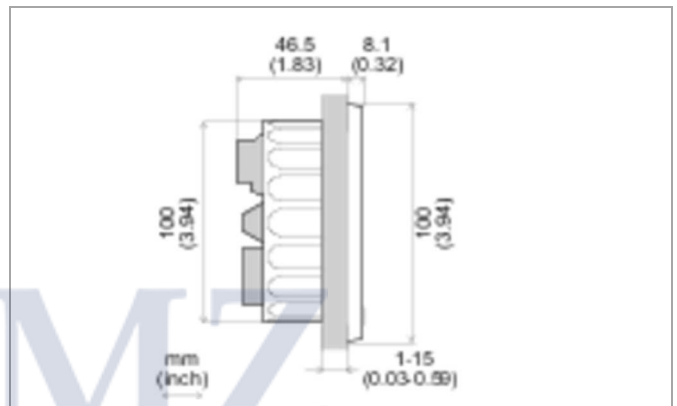

2. Remove the spinlock and insert the device from the front.
3. Orient the spinlock as shown according to the panel thickness.

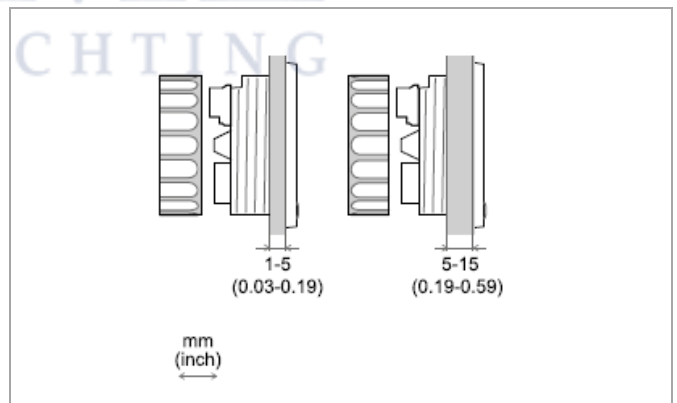

4. Feed the cables through the spinlock and carefully screw it in for at least two turns.
5. Install the connector.

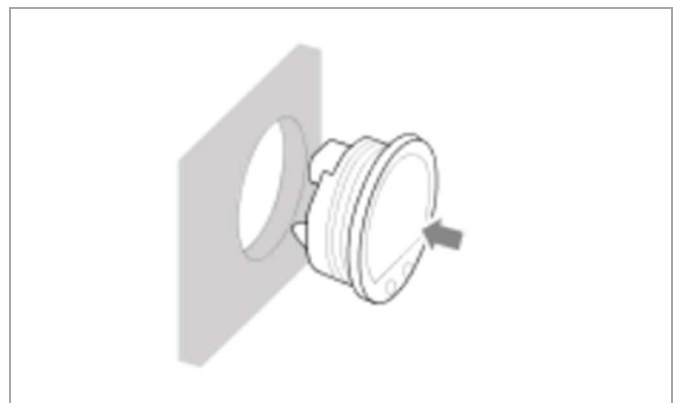

# ELECTRICAL CONNECTIONS

## ⚠ WARNING

- Refer to the safety rules described in the electrical connections section of the safety information chapter of this document!

### PINOUT

Pin No.	Wire Color	Description
1	Red	Ignition Power (Term. 15)
2	Black	Ground (Term. 31)
3	White	Alarm Output
4	Green	Frequency Input - RPM
5	Blue	SAE J1939 - CAN Low
6	Blue/White	SAE J1939 - CAN High
7	Yellow	Frequency Input - Log
8	Gray	Resistive Input 1
9	Brown	Resistive Input 2
10	Orange	Illumination (Term. 58)
11	Red	EasyLink - Power
12	Yellow	EasyLink - Data

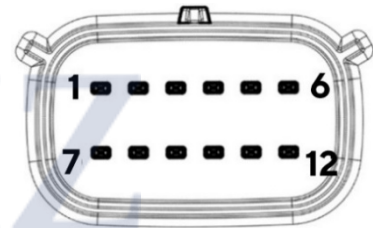

VMH 35 rear view  
Molex MX150 12-poles connector

### NMEA 2000® CONNECTOR PINOUT

Pin No.	Description
1	Shield
2	NET-S (V+)
3	NET-C (V-)
4	NET-H (CAN High)
5	NET-L (CAN Low)

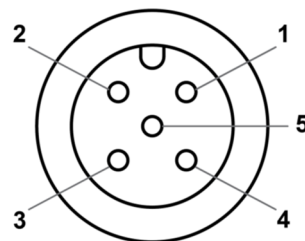

Micro-C M12 5 poles plug  
male, cable view

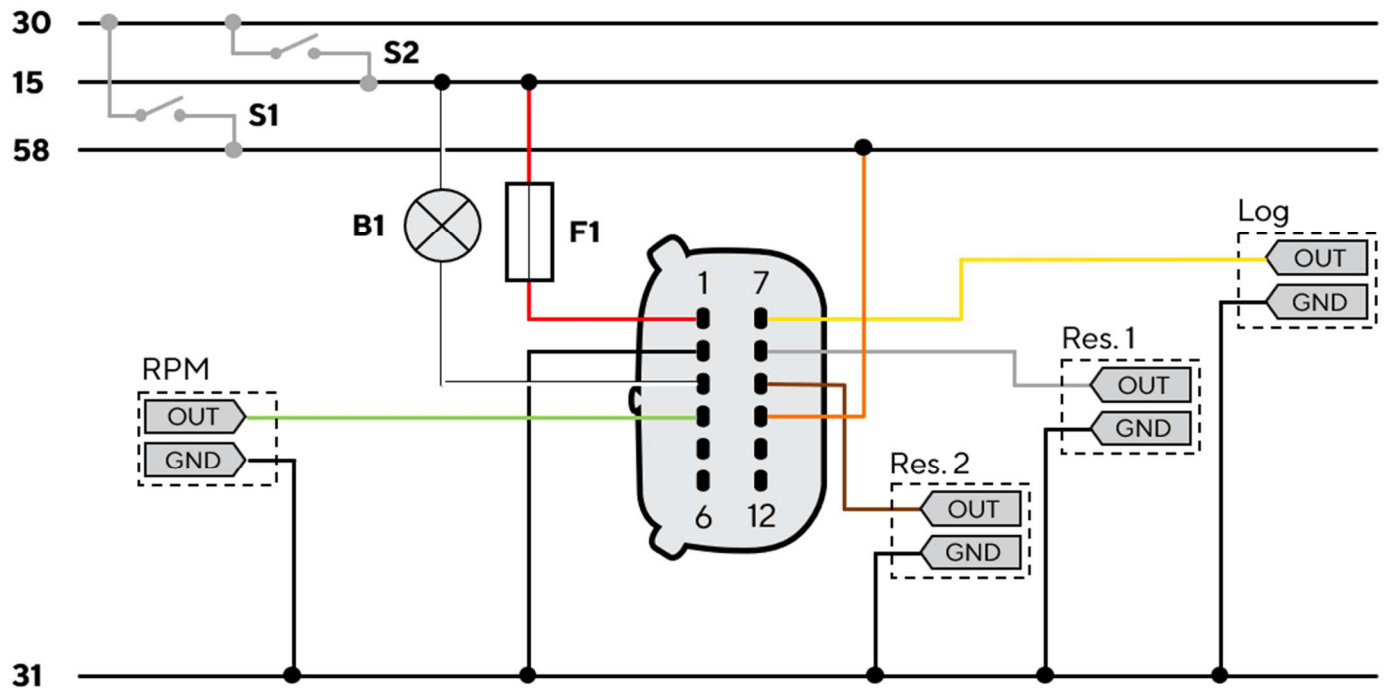

## ELECTRICAL SCHEMATIC

**Designations in the circuit diagram:**

**30** - KL.30 - Battery Power 12V/24V

**15** - KL. 15 - Ignition Power

**31** - KL. 31 - Ground

**58** - KL.58 - Illumination positive

**S1** - Day/Night mode switch (not included)

**S2** - Ignition key

**F1** - 3A fuse (not included)

**B1** - External buzzer (not included)

**Res.** - Resistive input

**RPM** - Frequency input for engine speed

**Log** - Frequency input for speed through water

**ANALOG SENSORS**

Any sensor connected to an analog input (Res, RPM and Log) of the display must be connected as shown in the schematic.

It is advisable to use sensors with isolated ground, and it is necessary to ensure that the sensor ground is connected to the display ground to avoid incorrect readings.

**EXTERNAL BUZZER (B1)**

The display supports the connection of an external buzzer (B1) via the dedicated alarm output.

This buzzer can be powered at different voltages (consult the buzzer manufacturer's manual) as the output steers the alarms ground connection (Open Collector Output).

It is important to note that the maximum current supported is 500mA.

### **DAY / NIGHT MODE SWITCH (S1)**

The display allows you to set two display illumination levels for day and night.

It is possible to switch from day mode to night mode (and vice versa) by means of a switch external to the display (S1) connected to the power supply or by connecting to the lights signal onboard KL.58, if present.

### **CONNECTION TO THE NMEA 2000® NETWORK**

Once the installation is complete, you can interface the device to the NMEA 2000® network through the dedicated socket.

Be sure to tighten the M12 connector by screwing it onto its counterpart in order to preserve its watertightness.

An accessory drop cable is required. (Not included)

Note that NMEA 2000® does not allow drop cables longer than 6 meters.

Refer to the NMEA 2000® standard for proper network design.



# DESCRIPTION

## DISPLAY SEGMENTS

Part	Description
A	Area to show data pages and menu
B	Current speed according to the selected unit of measurement
C	Engine speed
D	Gear position
E	Alarm telltales
<b>SET / MODE</b>	Buttons to interact with the data pages and the menu

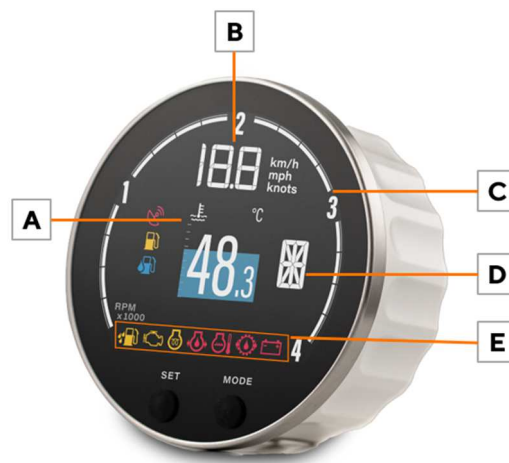

## DATA PAGES

Data pages are the templates that can be displayed on the center part of the device. There are single-layout screens, displaying only one value at a time and dual-layout screens, showing two.

Each of the pages can be hidden, as described in the section "Select the Pages to Display". By default, all pages are enabled.

### Single layout



### Dual layout

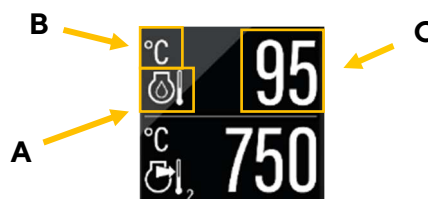

#### A: Data symbol

Indicates, which data type is displayed right now.

For the data types which support this function, there is also the instance indicated here.

#### B: Unit of measured value

Shows the unit of the currently displayed data.

For some data types it's possible to change the unit in the settings. (See table "List of Manged Data")

#### C: Current value

This shows the numeric value of the dedicated measured data. If there aren't any values received for this data type or they are out of range, the display will show "---".

#### Coloured Graph











The coloured graphic in the background of the single layout screen is a bar diagram that puts the measured value in perspective. This function isn't supported for all data types.

The white lines on the left side show the scalation.











## BASIC ACTIONS

To...	Then...
Open the menu	Keep <b>SET</b> pressed
scroll through the pages	To return to the previous page, briefly press the <b>MODE</b> button. To go to the next page, briefly press the <b>SET</b> button.
adjust the backlight	briefly press the <b>SET</b> and <b>MODE</b> buttons simultaneously
acknowledge the alarm pop-up	press any button

## MANAGED DATA

Icon	Information	Input signal						Output		Unit
		Intern	Freq.	Res.	LIN	NMEA 2000	J1939	NMEA 2000	Easy Link	
	Clock	X*	-	-	-	X	-	X	-	hh:mm
-	GPS position	X*	-	-	-	X	-	X	-	
<b>COG</b>	Course over ground (COG)	X*	-	-	-	X	-	X	-	°
<b>TRIM</b>	Trim	-	-	X	-	X	-	X	X	°
<b>RUDDER</b>	Rudder angle	-	-	X	-	X	-	X	X	°
	Depth	-	-	-	-	X	-	-	-	m, ft
	Seawater temperature	-	-	-	-	X	-	-	-	°C, °F
	Fuel level - tank no. #	-	-	X	-	X	X	X	X	%, L, Gal
<b>TTL</b>	Total fuel used	X	-	-	-	-	X	-	-	L, gal.
	Fuel flow	-	-	-	-	X	X	-	-	L/h, gph
<b>FRESH</b>	Fresh water	-	-	X	-	X	-	X	X	%, L, Gal
<b>WASTE</b>	Wastewater	-	-	X	-	X	-	X	X	%, L, Gal
	Voltmeter	X	-	-	X	X	X	X	X	V
	Ammeter	-	-	-	X	X	X	X	X	A
	State of Charge	-	-	-	X	X	-	X	-	%
	Battery autonomy	X	-	-	X	X	-	-	-	d, h
<b>SOH</b>	Battery Status of health	-	-	-	X	X	-	X	-	%
	Battery temperature	-	-	-	X	X	-	X	-	°C, °F

**DESCRIPTION**

Icon	Information	Input signal						Output		Unit
		Intern	Freq.	Res.	LIN	NMEA 2000	J1939	NMEA 2000	Easy Link	
	Engine coolant temperature	-	-	x	-	x	x	x	x	°C, °F
	Engine coolant pressure	-	-	-	-	x	x	-	-	Bar, psi
	Engine oil temperature	-	-	x	-	x	x	x	x	°C, °F
	Engine oil pressure	-	-	x	-	x	x	x	x	Bar, psi
	Boost pressure	-	-	x	-	x	x	-	x	bar, psi
	Total engine hours	-	x	-	-	x	x	x	-	h
<b>TRIP</b>	Trip hours counter	x	-	-	-	-	-	-	-	h
<b>TRIP</b>	Trip Distance	x	-	-	-	-	-	-	-	mi , km, nm
	Engine speed	-	x	-	-	x	x	x	-	rpm
<b>LOAD</b>	Engine Load	-	-	-	-	x	x	x	-	%
	Transmission oil pressure	-	-	x	-	x	x	x	x	bar, psi
	Transmission oil temp	-	-	x	-	x	x	x	x	°C, °F
	Exhaust gas temperature	-	-	-	-	x	x	x	-	°C, °F
<b>DEF/BLUE</b>	AdBlue level	-	-	-	-	-	x	-	-	%
	Air intake temp	-	-	-	-	-	x	-	-	°C, °F
-	Gear position	-	-	-	-	x	x	-	-	-
-	Speed through water (STW)	-	-	-	-	x	-	-	-	km/h ,mph , kn
-	GPS speed (SOG)	x*	-	-	-	x	-	x	-	km/h ,mph, kn

Note\*: data received from integrated GPS module.

**DISTANCE TRAVELED**

The indicator internally calculates the distance travelled based on the speed value set in **Sensors > Speed**.

## ENGINE HOURS

In the absence of data received from the CAN, the indicator considers the internally calculated data. Time is count when the engine speed exceeds 300 RPM. In the presence of data from the CAN, the indicator considers the data received from the network only if higher than the internal data.

When a higher engine hours value is received from the CAN bus this number gets stored internally and the gauge will count on from that value.

## PRIORITY OF DATA SOURCES

If one information received from several sources, the priority is judged as stated below:

In general

1. Analog Inputs
2. SAE J1939
3. NMEA 2000

Fuel data

1. Analog Inputs
2. NMEA 2000
3. J1939

GPS-Position

1. NMEA 2000
2. Internal GPS



# GENERAL SETTINGS

## SETTINGS MENU STRUCTURE

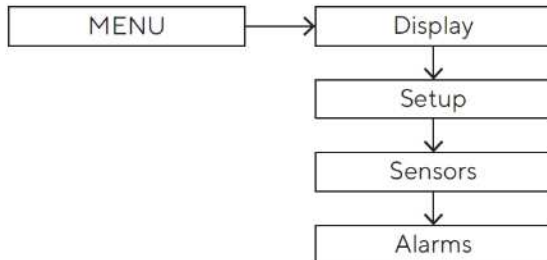

## OPERATE THE SETTINGS MENU

To...	Then...
enter the settings menu	press the <b>SET</b> button until the first menu item appears.
scroll through the settings menu items and possible values	<ul style="list-style-type: none"> <li>To go to the previous item/value, briefly press the <b>MODE</b> button.</li> <li>To go to the next item/value, briefly press the <b>SET</b> button.</li> </ul>
confirm	press the <b>SET</b> button until the data is confirmed.
come back	briefly press the <b>MODE</b> button
undo the change	Press the <b>MODE</b> button until the previous data appears.
exit the settings menu	press the <b>SET</b> and <b>MODE</b> buttons until the pop-up disappears, or the previous data page appears
close an alarm pop-up	press any button

## DISPLAY MENU STRUCTURE

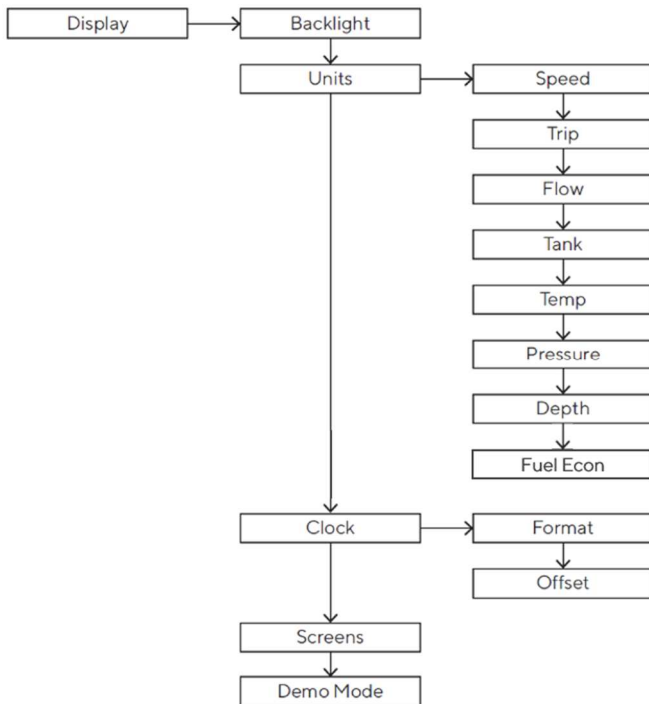

## CHANGE THE BRIGHTNESS OF THE DISPLAY

The change affects the set day or night mode.

- Press the **MODE** button until the **DISPLAY** menu appears with **BACKLIGHT** highlighted.
- Press the **SET** button to confirm the menu item.
- Press the **MODE** and/or **SET** buttons to increase or decrease the brightness.
- To exit the settings menu, press the **SET** and **MODE** buttons simultaneously until the previously displayed data page appears.

## SET THE DAY/NIGHT MODE

To set the desired mode, connect pin 10 of the MX150 plug to the following potential:

To set the mode...	Then...
day	move the pin switch to GND/OPEN.
night	move the pin switch to 12V/24V.



## UNITS

Setting	Description	Possible values/commands*
Speed	Speed units	km/h , mph, <u>kts</u>
Trip	Unit of measurement of distance travelled	km , mile , <u>nm</u>
Flow	Flow measurement units	<u>L/h</u> , gph
Tank	Unit of measurement for the liquid in the tank	<u>L</u> , US gal
Temperatures	Temperature units	<u>°C</u> , °F
Pressure	Pressure units	<u>bar</u> , PSI
Depth	Depth measurement units	<u>m</u> , ft

**Note:** the underlined value/command is the default.

## CLOCK

The time is only received via GNSS, it cannot be counted internally.

The clock settings can be found in the menu **Display > Clock** . To adapt the time to your current time zone, choose the according value in the submenu **Offset**.

To switch between the 12h and 24h time format, make the selection in the submenu **Format**.



## SELECT THE PAGES TO DISPLAY

By default, all pages are displayed.

You can choose which pages to hide/show in the menu under **Display > Screens**.

If you are working with the Veratron Diagnostic Tool, you can make the selection of shown and hidden screens faster by making this setting in the Configuration Tool.

**SETUP MENU**

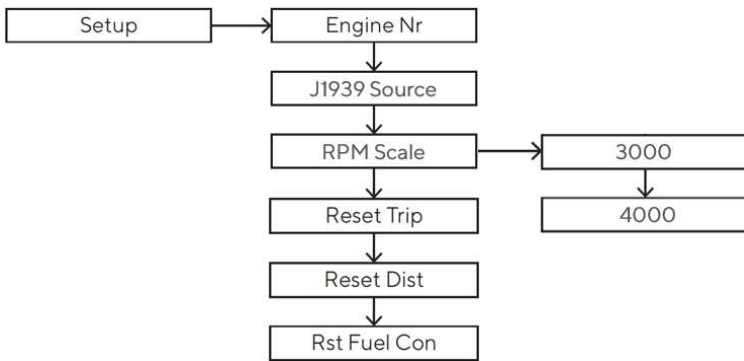

Setting	Description	Possible Values / Commands
Engine Nr.	Identification number of the engine whose data should be displayed on the gauge	1 - 4
Reset Trip	Partial hour counter reset (Trip).	Yes / No
Reset Distance	Partial distance counter reset (Trip).	Yes / No
Reset Fuel Consumption	Reset the fuel consumption counter	Yes / No



**ENGINE IDENTIFICATION**

The designation selected in the **SETUP > Engine No.** menu determines which engine data is to be displayed if more than one engine is present.

*Example: In a configuration with two engines and two VMH 35 displays (one for each engine), one instrument should be set as Engine 1 and the second as Engine 2.*

This setting does not affect the battery, fuel level or GPS data.

This setting also determines the designation used to transmit engine data from the VMH 35 display to the NMEA 2000 and EasyLink networks.

**SELECT A J1939 SOURCE**

Select which instance of engine information from the SAE J1939 network should be displayed on the VMH 35 screen in the menu **Setup > J1939 Src.**

For simple CAN bus networks with only one engine this can be left at the default value "Auto".

### ADJUST THE RPM SCALE

Adjust the layout of the RPM bar graph, by selecting the fitting maximum engine speed.

Applicable values are 3'000 or 4'000 RPM.

In order to support engines with engine speeds of up to 8'000 RPM the version VMH 35 (B00085501) or VMH 35-S (B00143501) is required.

### RESET A TRIP VALUE

- Press the **MODE** button until the **DISPLAY** menu appears.
- Briefly press the **MODE** and/or **SET** button to scroll through the pages to the one of interest.
- Press the **MODE** button until the page detail appears.
- Press and hold the **SET** button until the value resets.

### UPLOAD A CUSTOM SPLASH LOGO

A custom splash logo can be loaded from a PC using the Veratron Configuration Tool.

This logo will then be displayed each time during the startup sequence of the device.

For more information, please refer to the Veratron Configuration Tool user manual or contact your Veratron reseller.

# SENSOR CONFIGURATION

## TYPES OF CALIBRATION

Calibration of analog sensors can be:

- **Standard:** only for Veratron sensors. You define the type of sensor, and the device reads with good approximation the value of the sensor without the need of calibration.
- **Manual:** For non-Veratron sensors or to obtain a more accurate indication from a Veratron sensor. A three- or five-point procedure instructs the system to detect the sensor value.

## SENSORS MENU STRUCTURE

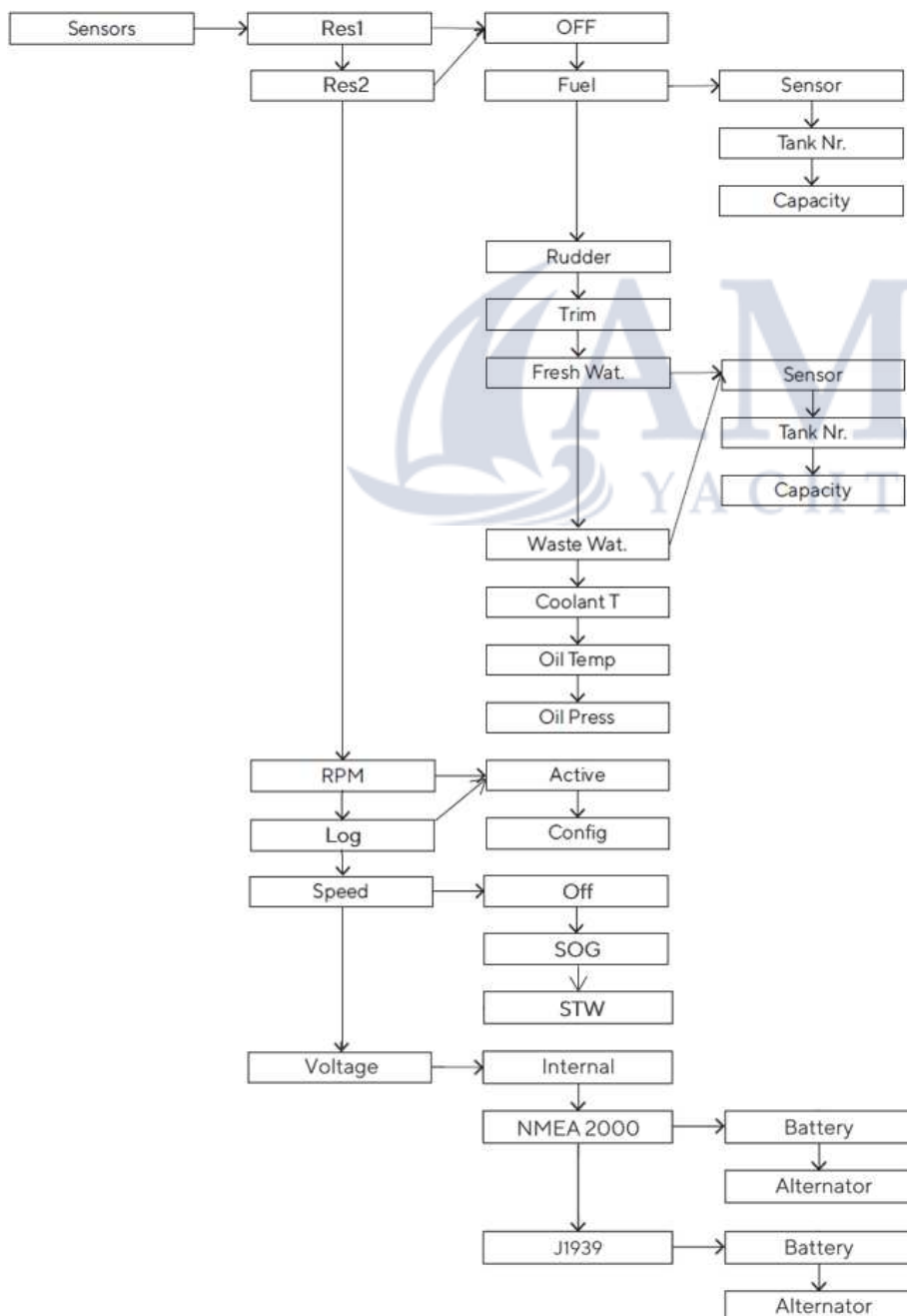

## CALIBRATE THE SENSORS

### FUEL LEVEL SENSOR

- Connect the sensor of interest. See "Connecting an analogue sensor".
- Under **Sensors** select the resistive or voltage depending input to which the sensor is connected.
- Under **Fuel > Sensor**, choose the desired configuration.
- If you have chosen the **CUSTOM** configuration, follow the wizard on the display to create the sensor curve. (You will have to fill your tank to a certain level and then confirm the current sensor value and repeat that for several points of the curve)
- Under **Sensors** select the resistive or voltage depending input of step 2.
- Under **Fuel > Tank no.**, select the ID to be assigned to the tank to which the sensor is connected.

### FRESH WATER LEVEL SENSOR

- Connect the sensor of interest. See "Connecting an analogue sensor".
- Under **Sensors** select the resistive or voltage depending input to which the sensor is connected.
- In **Fresh water > Sensor** choose the desired configuration.
- If you have chosen the **CUSTOM** configuration, follow the wizard on the display to create the sensor curve. (You will have to fill your tank to a certain level and then confirm the current sensor value and repeat that for several points of the curve)
- Under **Sensors** select the resistive or voltage depending input of step 2.
- Under **Fresh water > Tank no.**, select the ID to be assigned to the tank to which the sensor is connected.

### WASTEWATER LEVEL SENSOR

- Connect the sensor of interest. See "Connecting an analogue sensor".
- Under **Sensors** select the resistive or voltage depending input to which the sensor is connected.
- In **WASTE > Sensor** choose the desired configuration.
- If you have chosen the **CUSTOM** configuration, follow the wizard on the display to create the sensor curve. (You will have to fill your tank to a certain level and then confirm the current sensor value and repeat that for several points of the curve)
- Under **Sensors** select the resistive or voltage depending input of step 2.
- Under **Fresh water > Tank no.**, select the ID to be assigned to the tank to which the sensor is connected.

### RUDDER ANGLE SENSOR

- Connect the sensor of interest. See "Connecting an analogue sensor".
- Under **Sensors** select the resistive or voltage depending input to which the sensor is connected.
- In **Rudder** choose the desired configuration type.
- If you have chosen the **CUSTOM** configuration, follow the wizard on the display to create the sensor curve. (You will have to bring the rudder to a certain position and then confirm the current sensor value and repeat that for several points of the curve)

### TRIM SENSOR

- Connect the sensor of interest. See “Connecting an analogue sensor”.
- Under **Sensors** select the resistive or voltage depending input to which the sensor is connected.
- In **Trim** follow the wizard on the display to create the sensor curve. (You will have to bring the engine to a certain trim position and then confirm the current sensor value and repeat that for several points of the curve)

### RPM SENSOR

- Connect the sensor of interest. See “Connecting an analogue sensor”.
- In **Sensors > RPM > Config** enter the value of pulses/revolution required for a correct reading of the signal.

### LOG SENSOR

- Connect the sensor of interest. See “Connecting an analogue sensor”.
- In **Sensors > Log > Config** enter the value of pulses per length unit (as selected in **Display > Units**) required for a correct reading of the signal.

### TEMPERATURE AND PRESSURE SENSORS

- Connect the sensor of interest. See “Connecting an analogue sensor”.
- Under **Sensors** select the resistive or voltage depending input to which the sensor is connected.
- Choose the desired configuration for the connected sensor type.
- If you chose the **CUSTOM** configuration, create the sensor curve using the Veratron Configuration Tool.

### SELECTING A SOURCE FOR VOLTAGE DATA

The information battery voltage can be received from the different sources NMEA 2000, J1939 and the display-internal voltage measurement.

When receiving the data from a digital input it is required to define whether the information “battery voltage” or “alternator potential” should be displayed.

# SENSOR CURVES

## FUEL LEVEL SENSORS

Here are the possible alternatives:

Selectable value	Curve
ABYC-US	240-33 $\Omega$
EUROPE	3-180 $\Omega$
YAMAHA	105-5 $\Omega$
CUSTOM	Five-Step Calibration Wizard

## WATER LEVEL SENSORS

Here are the possible alternatives:

Selectable value	Curve
ABYC-US	240-33 $\Omega$
EUROPE	3-180 $\Omega$
CUSTOM	Five-Step Calibration Wizard

## RUDDER ANGLE SENSORS

Here are the possible alternatives:

Selectable value	Curve
Single	10-180 $\Omega$
Dual	5-90 $\Omega$
CUSTOM	Three-step calibration wizard

## COOLANT TEMPERATURE SENSORS

Here are the possible alternatives:

Selectable value	Curve
120°	291-22 $\Omega$
CUSTOM	Calibration via Veratron Configuration Tool

## OIL TEMPERATURE SENSORS

Here are the possible alternatives:

Selectable value	Curve
150°	197-11 $\Omega$
CUSTOM	Calibration via Veratron Configuration Tool

## ENGINE OIL PRESSURE SENSORS

Here are the possible alternatives:

Selectable value	Curve
5 bar	10-184 $\Omega$
10 bar	10-184 $\Omega$
CUSTOM	Calibration via Veratron Configuration Tool

## TRANSMISSION OIL PRESSURE SENSORS

Here are the possible alternatives:

Selectable value	Curve
10 bar	10-184 $\Omega$
20 bar	10-184 $\Omega$
CUSTOM	Calibration via Veratron Configuration Tool





# ALARMS

## ALARMS NOTIFICATION

The VMH 35 indicator shows internal active alarms and those coming from NMEA 2000. The **ALARMS** item allows you to set the alarms that can be generated by the indicator and the relative alarm thresholds.

In the event of an alarm, the following appears on the display:

- The alarm popup appears.
- The corresponding alarm lamp will light up if present.
- The buzzer is activated, if connected and set.
- If supported, the alarm is forwarded over the NMEA 2000 network.

## ALARMS MENU STRUCTURE

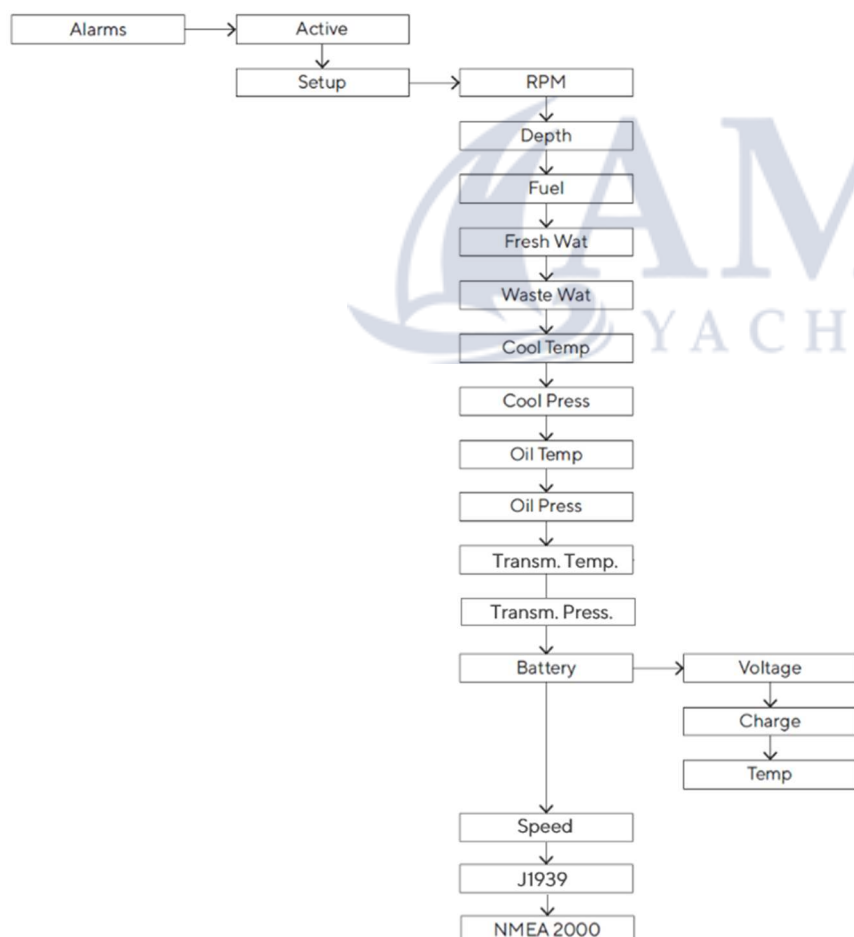

## SET AN ALARM

- In **ALARMS > Setup** select the value to activate the alarm and then **Active**.
- Set the desired alarm threshold.

## LIST OF MANAGED ALARMS

## Local alarms

- Engine Overtemp
- Battery low
- Overvoltage
- Battery low charge
- Battery Overtemp
- Low Oil Pressure
- Low Coolant Pressure
- Low Fuel #
- Low Fresh Water
- Waste Water Full
- Shallow Water
- Engine overspeed

## NMEA 2000









- Water in fuel
- Engine Overtemp
- Battery low
- Low Oil Pressure
- Check Engine
- Check Transmission
- Engine overspeed

## J1939

- Glow plug preheating
- Water in fuel
- Engine overtemperature
- Engine speed (DM1)
- Boost pressure (DM1)
- Exhaust gas temperature (DM1)
- Engine oil pressure (DM1)
- Engine coolant pressure (DM1)
- Engine oil temp (DM1)
- Transmission oil press (DM1)
- Transmission oil temp (DM1)
- Fuel Level (DM1)
- Low AdBlue level (DM1)
- Generic DM1 alarms



## ALARM TELLTALES

Icon	Information	Icon	Information
	Fuel level		Battery voltage
	Engine failure		Water in Fuel
	Engine coolant pressure		AdBlue Level
	Oil pressure		GPS*
	Engine coolant temperature		

\* **blinking**: no connection possible / **constantly on**: connection established

# TROUBLESHOOTING

Problem	Root cause	Solution
The values displayed are not as expected.	Incorrect sensor configuration.	Check the configuration in the Sensors menu.
	Sensor connected incorrectly.	Check the connection, refer to the Installation Instructions.
	The NMEA 2000 network backbone has not been created correctly.	Check the connections and that there is a termination at both the beginning and end of the backbone.
The value is not displayed / Only dashes displayed	Not available on the network.	Check that the sensor is functioning correctly.
	Sensor not connected.	Connect the sensor, refer to the <i>Installation Instructions</i> .
	The NMEA 2000 network backbone has not been created correctly.	Check the connections and that there is a termination at both the beginning and end of the backbone.
Slow update rate on NMEA data	The value is expected to be received from the analog input.	Disable the analog inputs when they are not being used.

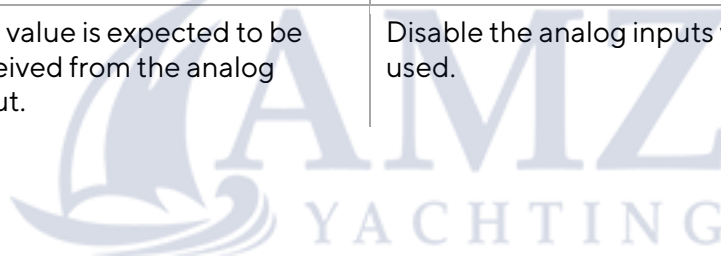

# TECHNICAL DATA

## GENERAL FEATURES

<b>Material</b>	Mineral glass front lens Stainless steel frame
<b>Connectors</b>	<ul style="list-style-type: none"> <li>• Molex MX150 (with EasyLink connector integrated in the pigtail cable)</li> <li>• NMEA 2000 Micro-C M12 5 Pin</li> </ul>
<b>Input data</b>	<ul style="list-style-type: none"> <li>• NMEA 2000</li> <li>• 2 analogue inputs (0-400 <math>\Omega</math>)</li> <li>• 2 frequency input (0-4 kHz)</li> </ul>
<b>Output data</b>	<ul style="list-style-type: none"> <li>• NMEA 2000</li> <li>• EasyLink</li> </ul>
<b>Degree of protection (according to IEC 60529)</b>	IP X7
<b>Display</b>	Hybrid with 1.44" central TFT and color IBN
<b>GPS Antenna</b>	Integrated, 10 Hz, 72 channels Supported constellations: GPS, GLONASS, Galileo

## ENVIRONMENTAL FEATURES

<b>Operating temperature</b>	From -20 to +60 °C
<b>Storage temperature</b>	From -30 to +80 °C

## ELECTRICAL FEATURES

<b>Nominal voltage</b>	12 V / 24 V
<b>Operating voltage</b>	9-32 V
<b>Current consumption</b>	< 170 mA @ 12 V
<b>Absorption (LEN)</b>	2

**COMPLIANCE**

<b>Compliance</b>	CE UKCA / UL94
<b>Directives</b>	2014/30/EU (Electromagnetic compatibility) 2011/65/EU (Hazardous substances in electrical and electronic equipment)
<b>Reference standards</b>	IEC 60945: 2002-08 (environmental class: exposed)

**SUPPORTED NMEA 2000 MESSAGES**

Description	PGN	Description	PGN
Navigation data	129284	Engine Parameters, Rapid Update	127488
GNSS dilution of precision (DOP)	129539	Engine Parameters, Dynamic	127489
GNSS satellites in view	129540	Transmission Parameters, Dynamic	127493
GNSS position data	129029	Trip Fuel Consumption, Engine	127497
Wind data	130306	Fluid level	127505
Environmental parameters	130310	DC Detailed Status	127506
Environmental parameters	130311	Battery status	127508
Temperature	130316	Speed: Water referenced	128259
Actual Pressure	130314	Water depth	128267
Engine Parameters, Static	127498	Position: Rapid update	129025
System time	126992	COG and SOG: Rapid update	129026
Rudder	127245	Local Time Offset	129033
Vessel heading	127250	Datum	129044

**DISPOSAL RESPONSIBILITY**



Dispose of by separate collection through government or local government designated collection facilities.

Proper disposal and recycling will help prevent potentially negative consequences for the environment and people.

# SPARE PARTS AND ACCESSORIES

Product	Part Number
Pigtail cable with MX150 connector	A2C14333300
Spin lock	A2C13760900
EasyLink extension cable	A2C59500139
Rubber gasket	A2C14624100

For all available accessories, visit <http://www.veratron.com>.





Veratron AG  
Industriestrasse 18  
9464 Rüthi,  
Switzerland

T +41 71 7679 111  
[info@veratron.com](mailto:info@veratron.com)  
veratron.com

---

Any distribution, translation, or reproduction of this document, in whole or in part, is strictly prohibited without the prior written permission of Veratron AG, except as noted below:

- Print the document in its original format, in whole or in part.
- Copy of contents without modification and declaration of Veratron AG as copyright owner.

Veratron AG reserves the right to make changes or improvements to this documentation without notice.

Requests for permission, additional copies of this manual, or technical information about this manual should be directed to Veratron AG.